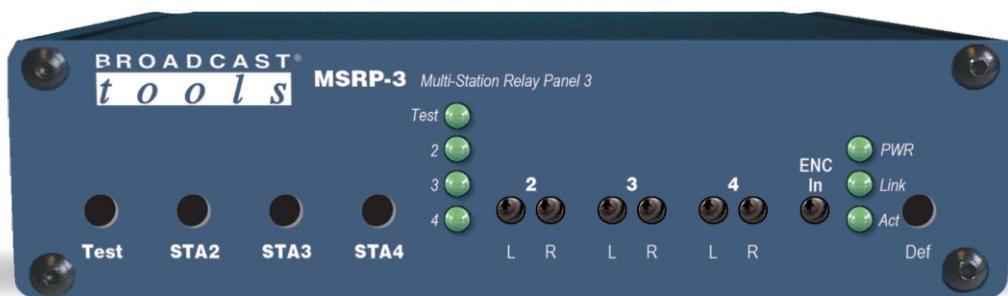


**BROADCAST**<sup>®</sup>  
**t o o l s** **INC**  
**PROBLEM SOLVED**

*Installation and Operation Manual*



**MSRP-3**  
**Three-Station Analog Stereo EAS Relay Panel**

Firmware Version 1.00 and above

Manual update: 07/1/2024

If you need a firmware upgrade, contact Broadcast Tools<sup>®</sup>

No part of this document may be reproduced or distributed without permission.  
ALL SPECIFICATIONS AND FEATURES FOR THIS PRODUCT ARE SUBJECT TO  
CHANGE WITHOUT NOTICE

NOTE: We recommend the use of Chrome, Firefox or Safari as your browser.

Due to the dynamic nature of product design, the information contained in this document is subject to change without notice. Broadcast Tools, Inc., assumes no responsibility for errors and/or omissions contained in this document. Revisions of this information or new editions may be issued to incorporate such changes.

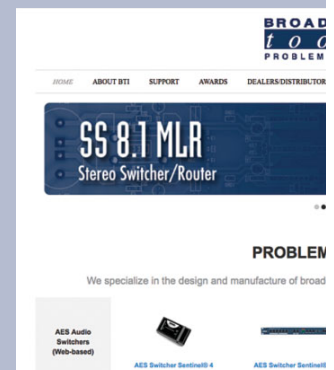
*Broadcast Tools<sup>®</sup> is a registered trademark of Broadcast Tools, Inc.  
All Sentinel<sup>®</sup> labeled products are registered trademarks of Broadcast Tools, Inc.  
Copyright<sup>®</sup> 1989 - 2024 by Broadcast Tools, Inc. All rights reserved.  
No part of this document may be reproduced or distributed without permission.  
Broadcast Tools is a Veteran Owned Business*

Visit [www.broadcasttools.com](http://www.broadcasttools.com) for important product update information.

## Table of Contents

Section Title	Page #
Introduction . . . . .	3
Safety Information . . . . .	3
Who to Contact for Help . . . . .	3
Product Overview . . . . .	4
Features/Benefits . . . . .	4
Applications . . . . .	4
Inspection . . . . .	4
Installation	
Surge Protection . . . . .	5
UPS standby power system . . . . .	5
Power/Grounding . . . . .	5
Installation/Operation . . . . .	5
Input selection push buttons . . . . .	5
LED Indicators . . . . .	5
I/O Connections . . . . .	5
Audio Inputs and Outputs . . . . .	6
RJ45 Audio Pinout . . . . .	6
Remote Control Inputs . . . . .	7
SPST Relay Outputs . . . . .	7
RS-232 Serial Port . . . . .	8
Optional NET/LAN Ethernet Port . . . . .	8
Configuration jumper setup . . . . .	8
Configuration	
Audio Connections . . . . .	9
Data Connection . . . . .	12
Audio Levels . . . . .	12
Command Reference . . . . .	14
Optional Ethernet Setup and Operation	
Ethernet “Quick Start” Guide . . . . .	15
Connecting via the Ethernet Port . . . . .	18
Changing network settings . . . . .	19
Specifications . . . . .	21
Warranty . . . . .	22
Front and rear panel drawings . . . . .	Appendix
Configuration jumpers and DIP-switch layout . . . . .	Appendix

**WEBSITE:**  
*Visit our web site for product updates and additional information.*



## INTRODUCTION

Thank you for your purchase of a Broadcast Tools® MSRP-3 three station analog EAS switcher (referred to as the MSRP-3 throughout this manual). We're confident that this product will give you many years of dependable service. This manual is intended to give you all the information needed to install and operate the Broadcast Tools® MSRP-3.

## SAFETY INFORMATION

Only qualified technical personnel should install the MSRP-3. Any attempt to install this device by a person who is not technically qualified could result in a hazardous condition to the installer or other personnel or damage to the MSRP-3 or other equipment. Please ensure that proper safety precautions have been taken before installing this device. If you are unfamiliar with this type of equipment, please contact a properly qualified engineer to handle the installation, and setup of the MSRP-3. Broadcast Tools, Inc., is unable to support NON-Broadcast Tools software, hardware, or NON-Broadcast Tools computer/hardware/software problems. If you experience these problems, please research your hardware/software instruction manuals, or contact the manufacturers technical support department.

## WHO TO CONTACT FOR HELP

If you have any questions regarding your product or you need assistance, please contact your distributor from whom you purchased this equipment. If you would like more information about BROADCAST TOOLS® products, you may reach us at:

### Broadcast Tools, Inc.

131 State Street  
Sedro-Woolley, WA 98284-1503 USA  
Voice: 360.854.9559  
Fax: 866.783.1742

Internet Home Page: [www.broadcasttools.com](http://www.broadcasttools.com)  
E-mail: [support@broadcasttools.com](mailto:support@broadcasttools.com)

THANK YOU FOR CHOOSING  
BROADCAST TOOLS® BRAND PRODUCTS!

Broadcast Tools is a Veteran Owned Business



Designed, Assembled and Supported in WA State, USA



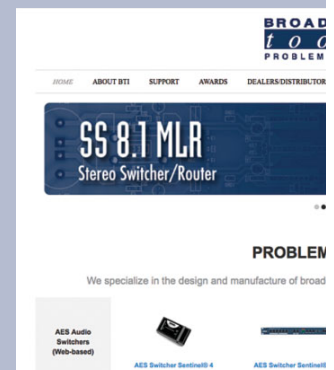
**Broadcast Tools®** Products, as with any electronic device, can fail without warning. Do not use this product in applications where a life threatening condition could result due to failure.



This manual should be read thoroughly before installation and operation.

### WEBSITE:

*Visit our web site for product updates and additional information.*



## INTRODUCTION

## Product Overview

The Broadcast Tools MSRP-3 is a three-station analog stereo emergency alert system (EAS) relay/switcher following in the footsteps of the original Multi-Station Relay Panel (MSRP) designed by Broadcast Tools for the Sage ENDEC in 1996. The MSRP-3 provides additional alert audio distribution and transparent audio interrupt switching for the Sage ENDEC and other EAS encoders. Together with the balanced stereo switched audio interrupt relay built into the ENDEC, an ENDEC and MSRP-3 will provide interrupt switching for four stereo audio paths. Each alert insertion can occur simultaneously on one or more station outputs, but alerts cannot be overlapped.

Standard pinout RJ45 station audio input and output jacks make installation with Cat5 or Cat6 patch cables plug and play. The encoder audio input is a balanced monaural 3.81mm pitch pluggable terminal block, with loop-thru. Control via RS-232 serial port (or optional TCP/UDP Ethernet port) or contact closure inputs. Includes SPST test and station relay outputs.

## Features/Benefits

- EAS alert insertion for up to three stations. Insertion can occur simultaneously on one or more station outputs, but alerts cannot be overlapped.
- Front panel test switches (recessed), jumper defeatable.
- Multi-turn front panel level adjustment trimmers for encoder input, and station outputs.
- Transparent signal switching via sealed mechanical relays utilizing 2 x 2-form-C bifurcated-crossbar silver alloy contacts with gold overlay.
- RJ45 station audio input and output jacks simplify wiring and service.
- Balanced monaural encoder audio input with loop-thru.
- SPST status relay outputs with LED indicators.
- Remote control via RS-232 serial (or optional TCP/UDP Ethernet) commands or contact closure inputs.
- Removable euroblock-style screw terminal connectors for status relays and contact closure inputs.
- Fully RFI proofed.
- Surge protected PS-1515/IEC universal switching +/-15VDC desktop power supply with locking connector and IEC AC inlet included. CE. (Supplied with domestic IEC AC power cord).
- Up to three units may be mounted on the optional RA-1 rack shelf. Desktop and wall mounting is also possible.

## Applications

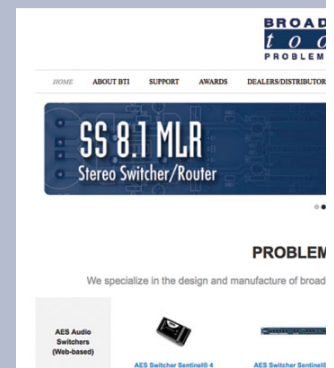
Multi-station EAS or other analog audio insertion switching.

## Inspection

Please examine your MSRP-3 carefully for any damage that may have been sustained during shipping. If any damage is present, please notify the shipper immediately and retain the packaging for inspection by the shipper. The package contains the MSRP-3, a modular cable with 9-pin “S9” female D-sub adapter, +/-15VDC universal desktop power supply with IEC AC inlet. Manuals can be downloaded from our web site.

## WEBSITE:

*Visit our web site for product updates and additional information.*



## OVERVIEW

## Installation

### Surge Protection

The MSRP-3 has built-in resistance to voltage changes; we recommend that you use a power surge protector or line conditioner on the incoming AC line. Lightning strikes and/or other high voltage surges may damage your MSRP-3 and connected equipment if it is not properly protected. For lightning protection devices, check out [www.polyphaser.com](http://www.polyphaser.com) and [www.itwlinx.com](http://www.itwlinx.com).

### UPS Standby Power System

We recommend that you connect your MSRP-3 to a UPS standby power system. A UPS, like the BE600M1 from APC helps to minimize the risk to the MSRP-3 and provides power during a power outage.

### Power

Insert the universal AC input PS-1515/IEC DC switching power supplies latching 3-pin connector into the power receptacle labelled “PWR” on the rear panel of the MSRP 3. When ready, plug the power supply into the appropriate AC receptacle.

**CAUTION! Only use the power supply provided with this product.**

Chassis Ground (CHS GND): The Chassis Ground (CG) terminal on the bottom TB1 terminal block connector should be connected to station ground via a low impedance connection.

### Station Selection and TEST recessed push buttons with LED Indicators

Each of the station switches can be tested via its recessed front panel push buttons labelled “STA2”, “STA3”, “STA4”. Switching for all three stations can be tested using the “TEST” push button. The user is required to hold down the desired station or test push button to activate. The front panel switches may be disabled via internal jumper.

### LED indicators

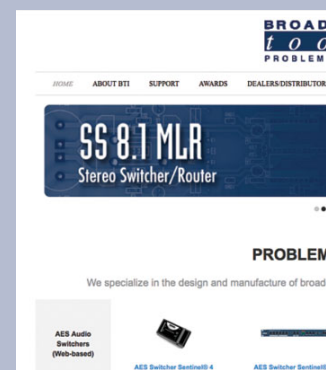
- “PWR” LED: Illuminates when power is applied and blinks when serial data is active. (Green)
- “LINK” LED: Lit when TCP connection is present via the optional Ethernet interface (Green).
- “Act” LED: Encoder audio level indicator, is lit when audio is present on the screw terminal input connector.
- “Station (Test, 2-4)” LEDs: illuminate when the station or test is active/switched to the encoder input. (Green)

### I/O Connections

The rear panel contains all the input, output, and remote-control connectors. The multi-drop serial port is equipped with a modular RJ-11 jack and an “S9” modular to DB9 adapter/cable.

### WEBSITE:

*Visit our web site for product updates and additional information.*



## INSTALLATION

## Installation/Operation

### Encoder Audio Input/Loop-Thru (3-position TB)

The MSRP-3 features a balanced mono analog input (Encoder In) for alert/encoder audio from the ENDEC as well as a pass-thru output on 3-position pluggable screw terminal block connectors.

The input is labeled: “IN+”, “IN-”, and “GND”. For a balanced audio source like the Station Output XLR from the ENDEC connect XLR pin 1/cable shield to Ground (GND), XLR pin 2 to IN+ and XLR pin 3 to IN-. For unbalanced sources like the Speaker Line Out output from the ENDEC install a jumper between the "-" input and Ground (GND). The loop-thru output connector is wired in parallel with the Encoder Input connector.

#### J6 Top

Loop-thru+	Loop-thru-	Gnd
IN+	IN-	Gnd

#### J6 Bottom

### Station Inputs and Outputs (RJ45)

<b>STA2 IN</b> (Station 2 In)	<b>STA3 IN</b> (Station 3 In)	<b>STA4 IN</b> (Station 4 In)
<b>STA2 OUT</b> (Station 2 Out)	<b>STA3 OUT</b> (Station 3 Out)	<b>STA4 OUT</b> (Station 4 Out)

Input sources that are NOT selected are terminated with a 100K-ohm resistor.

The station input and output RJ45 jacks conform to the RJ45 analog audio wiring standards.

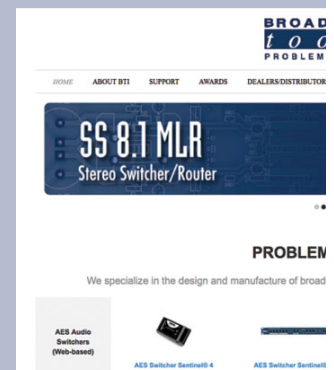
Please use shielded twisted pair Cat5e or Cat6 cables and connectors (STP).

### RJ45 Pinout:

Function:	Wire Pair:	RJ45 Pins:
Left+	White/Orange	1
Left-	Orange/White	2
Right+	White/Green	3
Right -	Green/White	6
n/c	White/Blue	5
GND	Blue/White	4
n/c	White/Brown	7
n/c	Brown/White	8
GND	Shield	Shield

### WEBSITE:

*Visit our web site for product updates and additional information.*



## INSTALLATION

**Remote Control Inputs**

The MSRP-3 can interface to external equipment through removable euro-block screw terminals. The terminals accommodate wire sizes from 16 - 28 AWG solid or stranded wire. Before installing a wire, remove the euro-block screw terminal plug and turn each capture screw fully counterclockwise. Strip each conductor to a length of 0.25” and insert the conductor fully into the terminal. Turn the capture screw fully clockwise to secure the conductor.

The MSRP-3’s four remote-control inputs accept sustained contact closures, open collector, or 5-volt TTL/CMOS input logic levels.

(Top row, TB1)  
**Remote Control Inputs & Test Relay**

Station Test In	Station 2 Activate In	Station 3 Activate In	Station 4 Activate In	Test (K1) Relay N.O.	Test (K1) Relay Common
-----------------------	--------------------------------	--------------------------------	--------------------------------	-------------------------------	------------------------------

The remote-control inputs are triggered by sustained closure to ground (low.) For example, holding the “TEST” input to ground would activate the TEST function switching all three stations to the encoder audio.

**Relay Outputs**

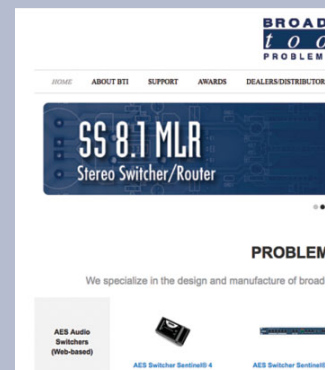
The MSRP-3 has four normally open (N.O.) relay outputs that are used to indicate switching state and test stations. K1 indicates for the Test feature. K2 indicates for Station 2, K3 for Station 3, and K4 for Station 4. The status relay output for the selected channel will connect to the relay common providing a return for an LED indicator, TTL/CMOS logic, or relay.

(Bottom row, TB1)  
**Relay Outputs**

K2 Relay N.O.	K3 Relay N.O.	K4 Relay N.O.	Relay K 2, K3, K4, Common.	GND (Ground)	CHS GND (Chassis Ground)
---------------------	---------------------	---------------------	-------------------------------------	-----------------	-----------------------------

**CAUTION!** Installation of the MSRP-3 in high RF environments should be performed with care. The station ground should be connected to the designated chassis ground terminal using a 20 to 24-gauge wire. Note: For wiring information, refer to the grids in this section of the manual, the silk-screen text on the rear panel of the product or the fractional schematic in the appendix.

**WEBSITE:**  
*Visit our web site for product updates and additional information.*



### RS-232 Serial Port (RJ-11 Jack):

This RJ-11 jack is used to connect the MSRP-3 to a serial port on the ENDEC or other device for RS-232 serial operation using the included reverse modular cable with 9-pin “S9” female D-sub adapter.

### NET/LAN Ethernet Port (Optional):

The optional 10/100 Ethernet port replaces the RS-232 serial port and is used to connect the MSRP-3 to a computer for control via telnet/TCP socket connections. See the “Ethernet” and “Programming” sections of this manual for more information.

### Configuration Jumpers:

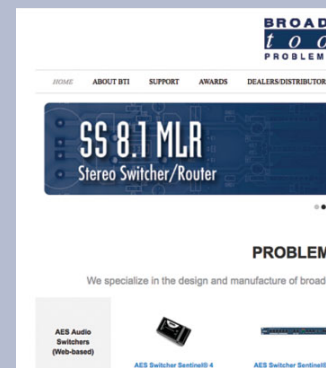
JP2: Front Panel Controls Enable/Disable

Enabled = Front panel control enabled. Jumper installed on pins 1&2  
(Factory default)

Disabled = Front panel controls disabled. Jumper installed on pin 2&3.

### WEBSITE:

*Visit our web site for product updates and additional information.*



## Installation

To completely install the MSRP-3 you must perform the following steps:

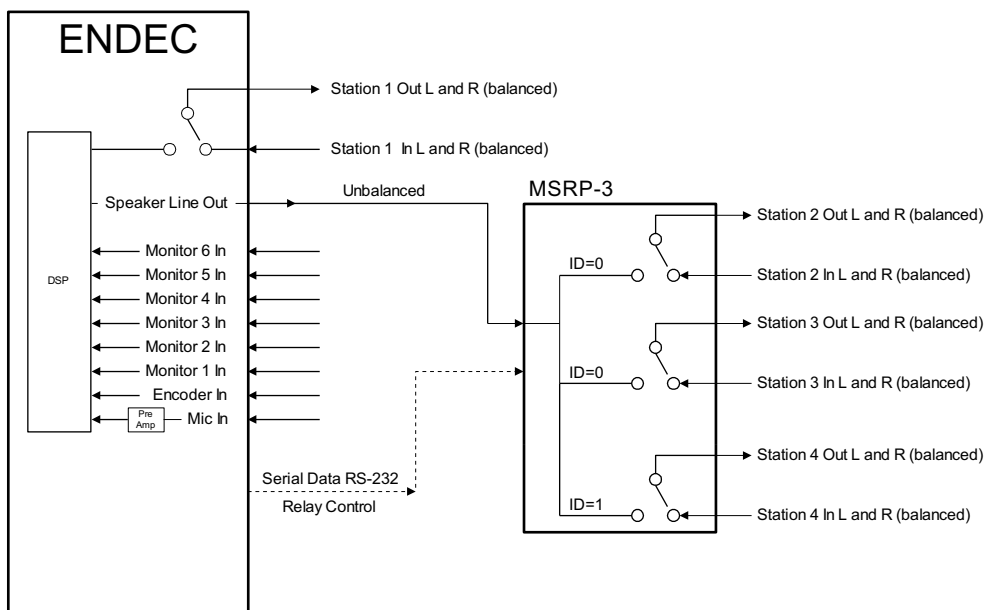
- 1) Connect the ENDEC Alert audio output to the MSRP-3's Encoder Audio Input, using either balanced (XLR) or unbalanced (Speaker Line Out) outputs.
- 2) Connect the serial port to the ENDEC COM4 or COM5 using the S9 modular adapter and the reverse modular cord.
- 3) Assign the chosen ENDEC serial port to the "RELAY" device on the ENDEC.
- 4) Connect the PS-1515/IEC power supply to the MSRP-3.
- 5) Set the MSRP-3 audio levels.
- 6) Configure multiple station support on the ENDEC (see the ENDEC manual or the ENDEC Multi-station Manual Supplement for details).

**We recommend that you bench test and become familiar with the operation of the unit before permanent installation.**

The MSRP-3 is designed to be rack mounted in a standard 19" rack with the optional RA-1 rack shelf with filler panel if only one MSRP-3 is used. It should be mounted in an area that is accessible from the rear and preferably away from sources of heat.

## Audio Connections

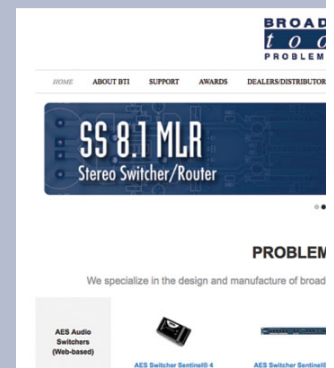
The MSRP-3 and the ENDEC provide alert audio and interrupt switching as shown in the following two figures. Figure 1 shows how to use the ENDEC's internal interrupt and feed unbalanced audio to the MSRP-3. Figure 2 shows how to use the ENDEC to provide balanced output to the MSRP-3, using only the MSRP-3 to provide interrupt switching.



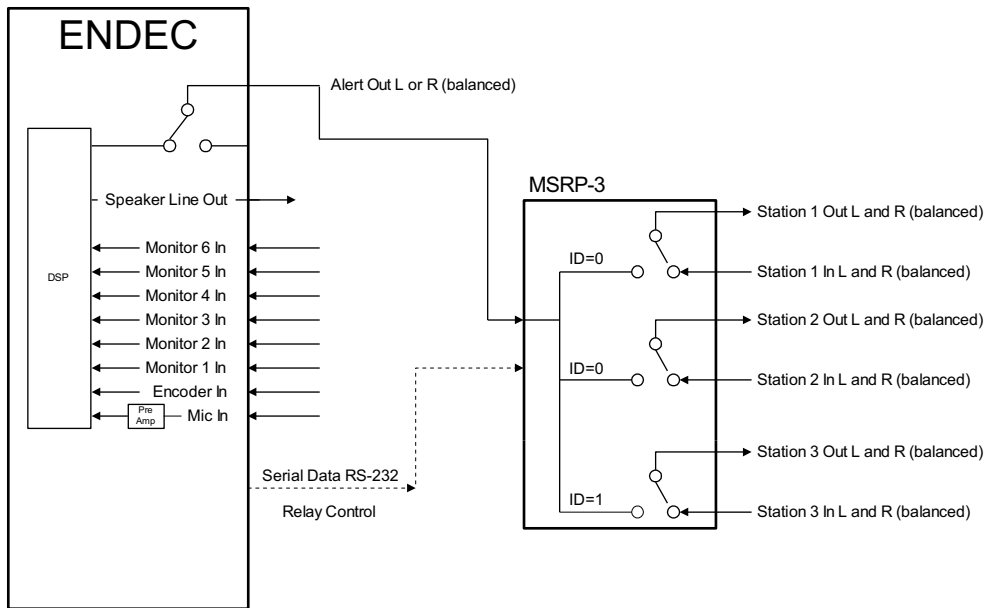
**Figure 1. Multi-station configuration using the ENDEC interrupt relay and unbalanced distribution audio.**

## WEBSITE:

*Visit our web site for product updates and additional information.*



The station audio inputs and outputs on the MSRP-3 are made using standard pinout RJ45 audio jacks. The MSRP-3 interfaces to the ENDEC's alert audio output through removable euroblock screw terminals. The terminals accommodate wire sizes from 16 - 28 AWG solid or stranded wire. Before installing a wire, remove the euroblock screw terminal plug and turn each capture screw fully counterclockwise. Strip each conductor to a length of 0.25" and insert the conductor fully into the terminal. Turn the capture screw fully clockwise to secure the conductor. Verify that no bare wires are exposed. Connections may be made to the + and - inputs and outputs for balanced operation. In no case should either the + or - outputs be connected to ground.



**Figure 2. Multi-station configuration using the ENDEC to provide a balanced audio source and the MRSP-3 for program interruption.**

Connect each station as follows:

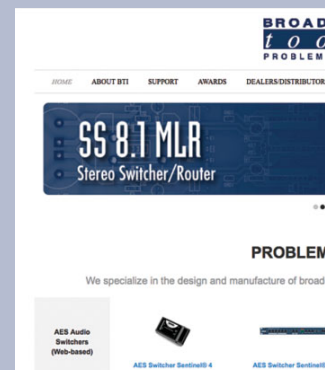
- |                     |                      |
|---------------------|----------------------|
| Station 2 IN (RJ45) | Station 2 Out (RJ45) |
| Station 3 IN (RJ45) | Station 3 Out (RJ45) |
| Station 4 IN (RJ45) | Station 4 Out (RJ45) |

ENDEC speaker line out +(unbalanced)      IN+ (Alert Audio Input)

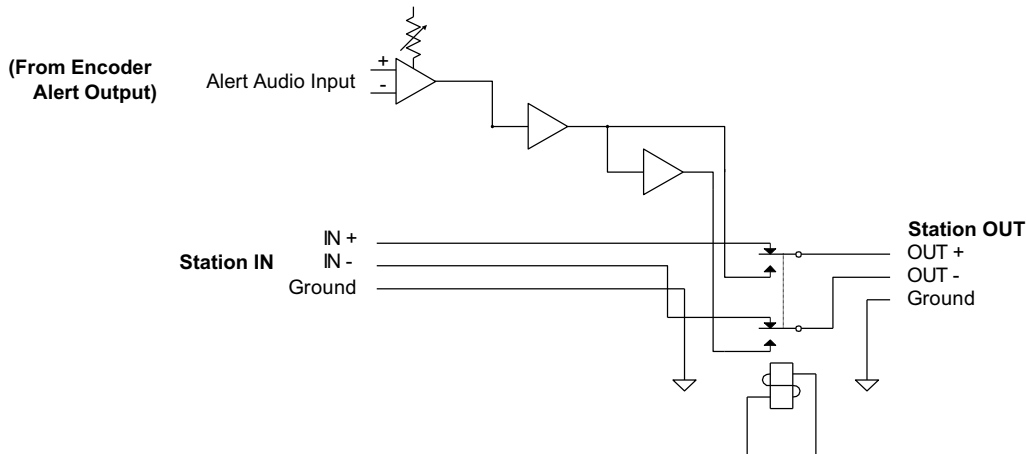
Ground      GND

## WEBSITE:

*Visit our web site for product updates and additional information.*



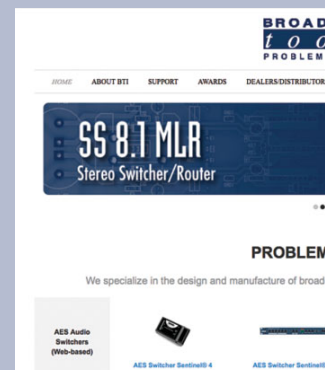
The impedance of both output channels is designed for 600Ω termination when in the alert condition. The Loop-thru terminals on the MSRP-3 are in common with Input terminals and can be used to daisy chain to a second device. If you wish to use balanced output from the ENDEC as shown in Figure 1, connecting the ENDEC Main/Alert Left XLR output + and - to IN+ and IN- (Encoder In) on the MSRP-3. Alternatively, you can use the unbalanced Speaker Line Out output from the ENDEC and install a wire jumper between the "-" input and Ground (GND)



**Figure 3. Typical relay showing in and out routing.**

**WEBSITE:**

*Visit our web site for product updates and additional information.*



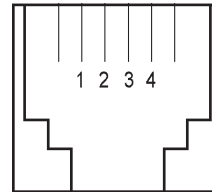
**INSTALLATION**

## Data Connection

Use the provided modular/9 pin D-sub connector adapter and line cord (S-9) to connect the MSRP-3's serial connector (J2) to an ENDEC serial port. Use either COM4 or COM5 (1200 baud ports) on the ENDEC. Set the port to the "RELAY" device using the ENDEC's **menu.devices.port.device type.relay**<sup>1</sup> command.

The pin out of the adapter is shown below.

RJ-11 Adapter Pin	DB-9 Pin	Use (ENDEC Point of view)
1	3	RS-232 Transmit
		RS-232 Receive
3	5	Ground



Use only the modular cord that comes with the MSRP-3 or a replacement that reverses like Monoprice UPC # 844660009290

The MSRP-3 J2 pin out is shown below.

MSRP-3 RJ-11 Pin	Signal Name (MSRP-3 point of view)
2	Ground
4	RS-232 Receive
3	RS-232 Transmit

## Audio Levels

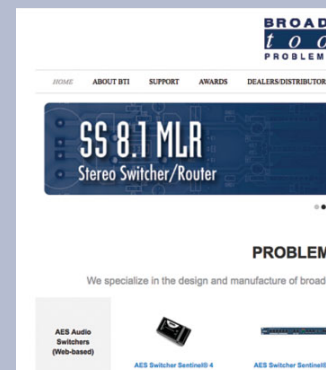
Once the input and output connections have been made, the input levels may be set. The MSRP-3 is factory set for unity gain. The output level of the SAGE ENDEC (input to MSRP-3 encoder IN+ and IN-) should be in the range of -15 dBm to +8 dBm. Each Station output has two output adjustments. They are labeled 2L, 2R, 3L, 3R, 4L, and 4R allowing adjustment for each channel. The station outputs on the MSRP-3 can add an additional 10 dB of gain from the factory settings. Hold down the front panel test switch, while adjusting the desired output channel. If an additional level adjustment is needed, adjust the encoder input level trimmer labeled "ENC IN". To provide a test signal out of the ENDEC, use the **menu.monitor source.attn tone**<sup>2</sup> menu to provide a two-tone signal. The ENDEC output levels should be properly set before setting the MSRP-3 levels.

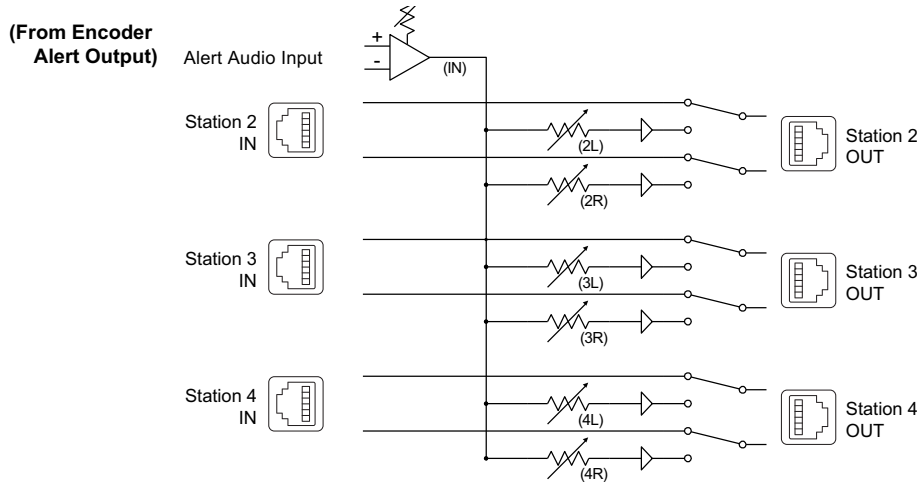
<sup>1</sup> See the ENDEC manual for a description of this command.

<sup>2</sup> See the ENDEC manual for a description of this command.

## WEBSITE:

Visit our web site for product updates and additional information.

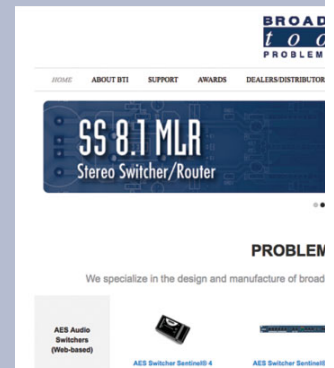




**Figure 5. Audio paths, showing the location and names of the level setting pots Encoder In (ENC IN), 2L, 2R, 3L, 3R, 4L, and 4R.**

**WEBSITE:**

*Visit our web site for product updates and additional information.*



**INSTALLATION**

## Command Reference

1200 baud 8, N, 1.

\* = Beginning of string

u = unit ID (stations 2 & 3 = 0, station 4 = 1) (0-1)

# = Selection of relay(s) to control. Comma separated or individual (1-4)

\$ = M to MUTE and A to ACTIVATE

<cr> = Carriage return

\*0U will cause the switcher to send its firmware name/version as a response.

\*0Zx Echo character x to control port - for debugging command strings.

ID 0, Relays 1 & 2 = Station 2

ID 0, Relays 3 & 4 = Station 3

ID 1, Relays 1 & 2 = Station 4

Formatting example: \*u#,#,\$<cr>

Functional example \*01,2,3,4,A<cr>

ID 0, Activate Station 2, Station 3

We're doubling up relays for backward compatibility, so sending \*01,3,A<cr> or \*02,4,A<cr> should produce the same result.

Functional example \*01,2,3,4,M<cr>

ID 0, Mute Station 2, Station 3

Functional example \*01,2,3,4,A<cr>\*11,2A<cr>

ID 0, Activate Station 2, Station 3, ID 1, Activate Station 4

## Individual commands

\*01A<cr> = Activate Station 2

\*01M<cr> = Mute Station 2

\*02A<cr> = Activate Station 2

\*02M<cr> = Mute Station 2

\*03A<cr> = Activate Station 3

\*03M<cr> = Mute Station 3

\*04A<cr> = Activate Station 3

\*04M<cr> = Mute Station 3

\*11A<cr> = Activate Station 4

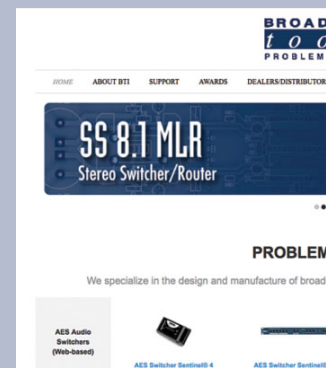
\*11M<cr> = Mute Station 4

\*12A<cr> = Activate Station 4

\*12M<cr> = Mute Station 4

## WEBSITE:

Visit our web site for product updates and additional information.



## INSTALLATION

## Ethernet Setup and Operation (Optional Ethernet Interface) Ethernet “Quick Start” Guide

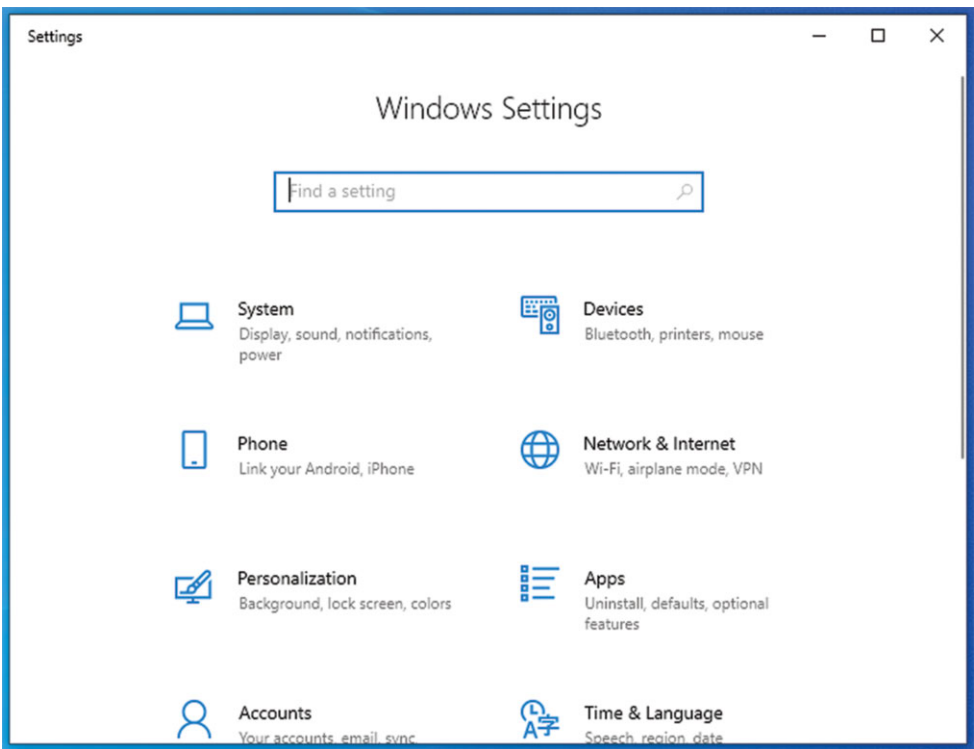
**CAUTION! NEVER DOWNLOAD FIRMWARE UPDATES OR CHANGES TO THE WEB SERVER UNLESS INSTRUCTED TO DO SO BY BROADCAST TOOLS®. DOING SO DELETES ALL SOFTWARE AND VOIDS ALL WARRANTIES FROM BROADCAST TOOLS, INC.**

**CAUTION!** If you are not familiar with Ethernet enabled equipment, it may be useful to contact your IT department, network administrator or network consultant for assistance. Assigning an IP address already in use by another device may cause problems with your network!

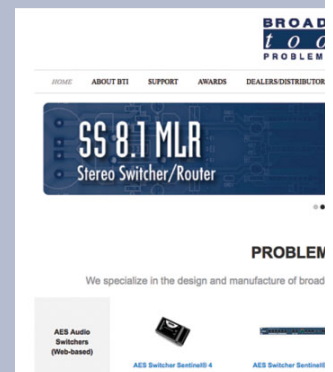
Instructions for changing the IP address of the computer that will be used for the configuration of this product are given here. Note that these instructions are specifically for computers with the Windows 10 operating system but will also work with Windows 7. For setup using other operating systems, refer to the appropriate OS user’s manual.

**NOTE: We recommend the use of Chrome, Firefox, or Safari as your browser.**

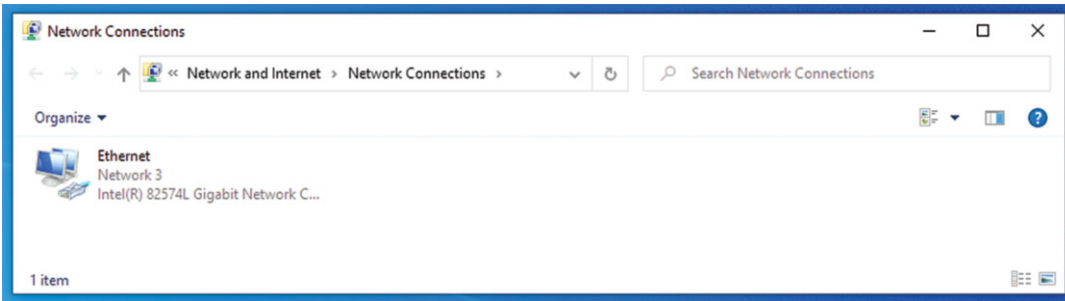
**Step 1:** Open the control panel by clicking on the Start Menu, click on Settings, then click on Network & Internet.



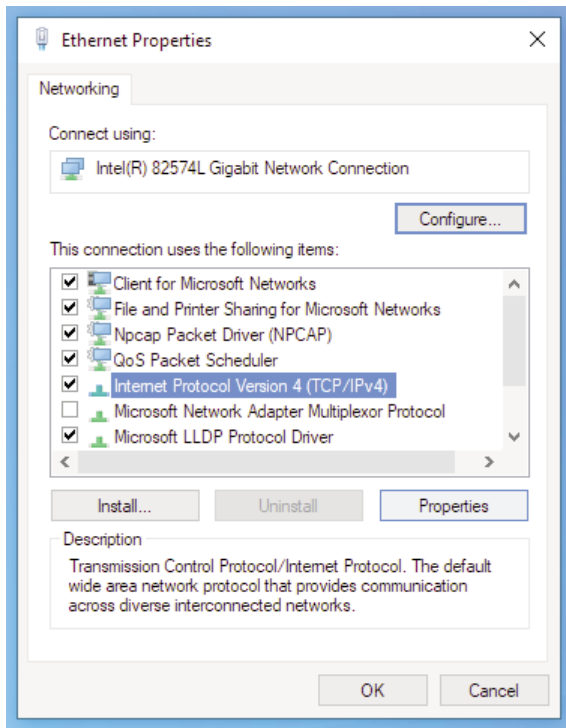
**WEBSITE:**  
*Visit our web site for product updates and additional information.*



**Step 2:** Under Advanced Network Settings click Change adapter settings. The Network Connections windows will pop up, as shown below.

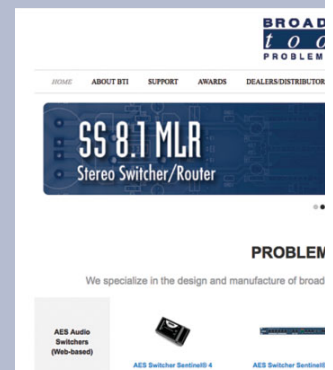


**Step 3:** Right click on the icon labeled Local Area Connection or Ethernet. A menu will appear. Select the option at the bottom of the menu labeled Properties. The Ethernet Properties window will appear.

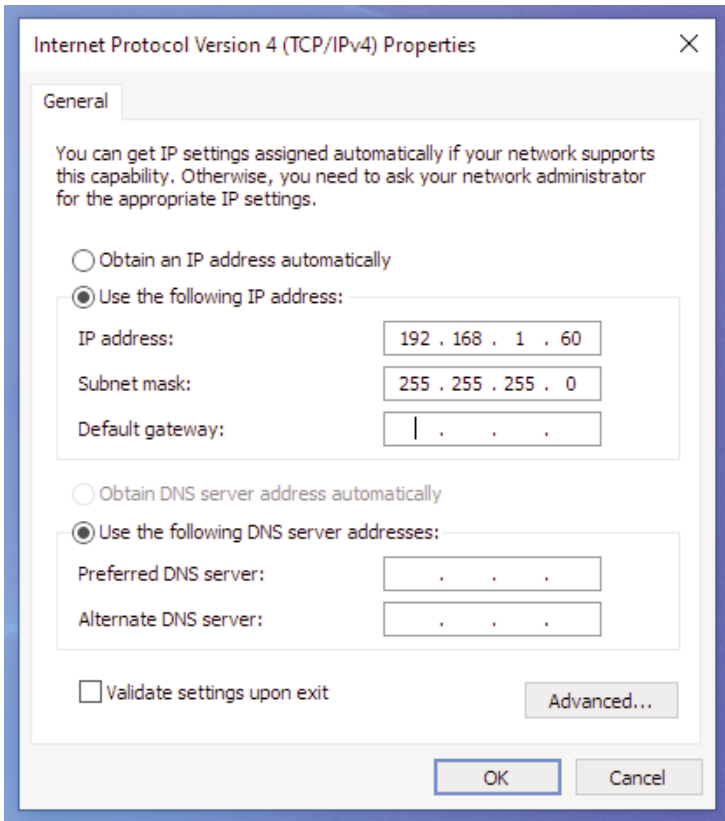


## WEBSITE:

*Visit our web site for product updates and additional information.*



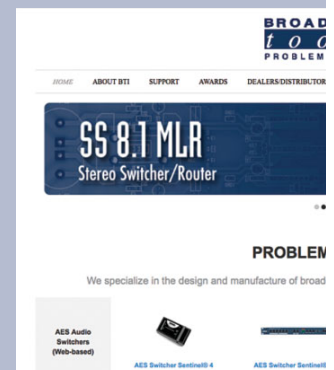
**Step 4:** On the Local Area Connection Properties page, double click on Internet Protocol (TCP/IPv4) to display properties.



**Step 5:** Before making any changes to the network settings, write down the current settings (or screen capture the page and print) so that they can be restored once the unit is configured. Next, select the radio button labeled “Use the following IP address” and type in the IP address 192.168.1.60. Type in the subnet mask of 255.255.255.0. Leave the default gateway field blank. Click OK to apply the new settings.

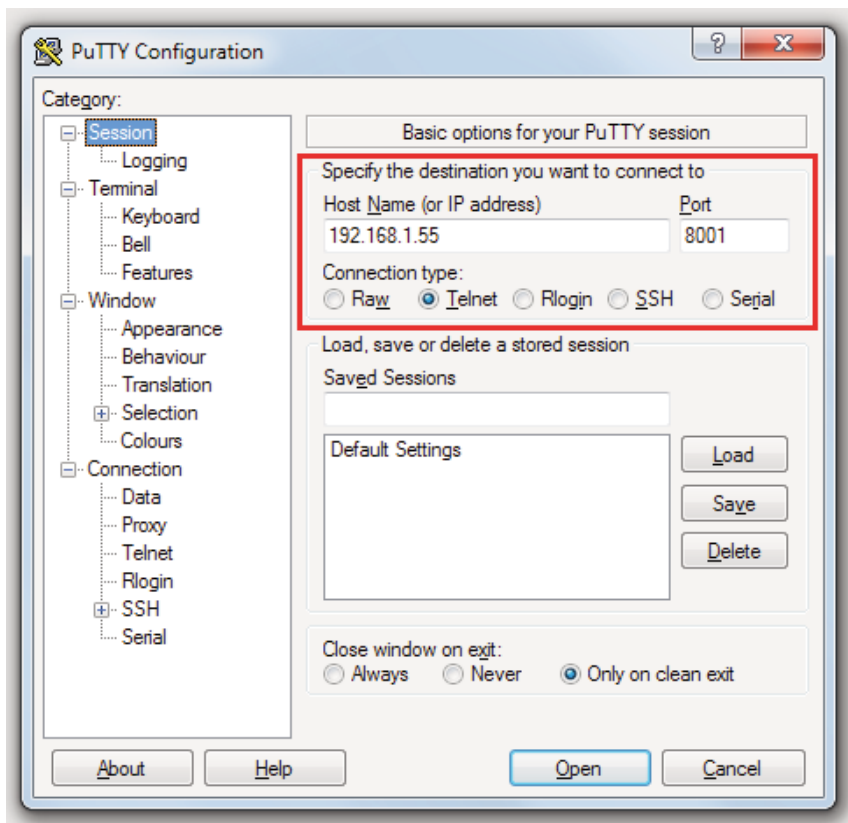
## WEBSITE:

*Visit our web site for product updates and additional information.*



## Connecting via the Ethernet “COM” port:

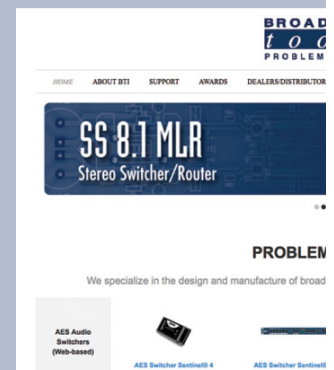
1. Connect the supplied GRAY colored XOVER cable between the PC’s Ethernet port and the products “NET/LAN/” network RJ45 jack.
2. Connect the included power supply to the MSRP-3. Verify that the green PWR LED is lit and the green “LINK” LED to the left of the “COM” Network RJ45 jack is illuminated.
3. Open terminal application PuTTY configured for a Telnet connection type to host 192.168.1.55 port 8001.



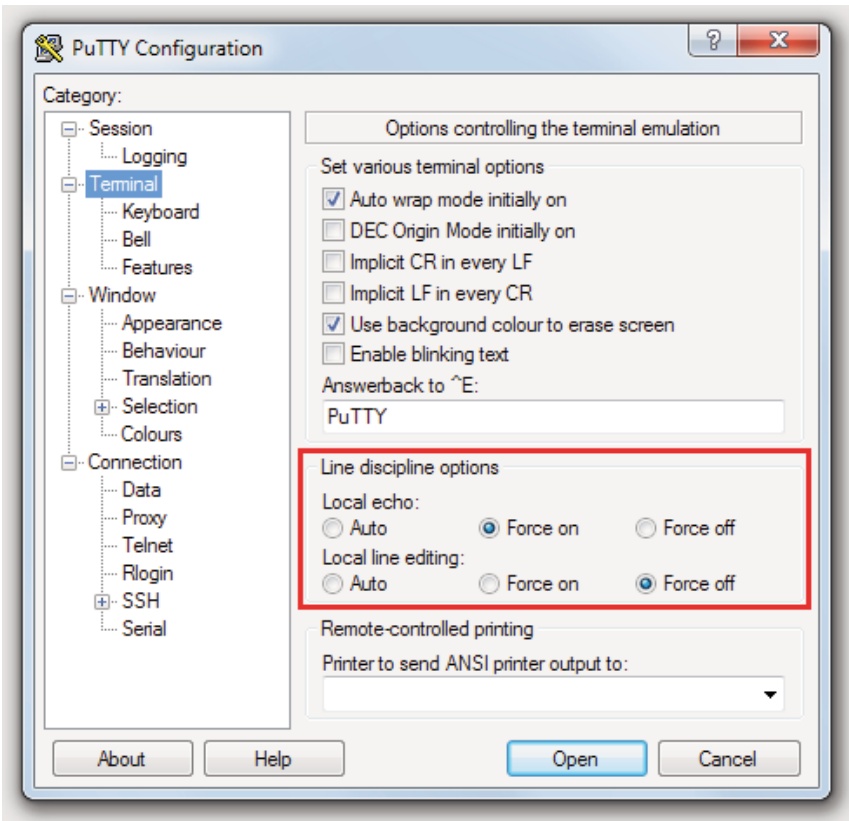
4. In PuTTY configuration > Terminal > Line discipline options set Local echo “Force on” and Local line editing to “Force off”.
5. Click okay to connect to the MSRP-3 and type \*0u into the terminal window and press return to verify connectivity.

## WEBSITE:

Visit our web site for product updates and additional information.



Changing network settings on the Ethernet “NET/LAN” port:

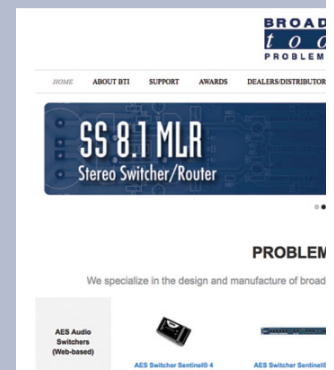


**NOTE:** We recommend the use of Chrome, Firefox, or Safari for as your browser.

1. Connect the supplied GRAY colored XOVER cable between the PC’s Ethernet port and the products “NET/LAN” network RJ45 jack.
2. Connect the included power supply to the MSRP-3. Verify that the green PWR LED is lit and the green “LINK” LED to the left of the “COM” Network RJ45 jack is illuminated.
3. Open a web browser window and navigate to the MSRP-3’s default IP address: <http://192.168.1.55>
4. When prompted to login, use the default login and password. Login: admin Password: 1234
5. To change the network settings, choose “Local IP Config” from the side bar:

**WEBSITE:**

*Visit our web site for product updates and additional information.*



Current Status	parameter			
Local IP Config	IP type:	Static IP ▼		
Serial Port	DNS type:	Manual ▼		
Expand Function	Static IP:	192	168	1 . 55
Misc Config	Submask:	255	255	255 . 0
Reboot	Gateway:	192	168	1 . 1
	DNS Server:	8	8	8 . 8
	<input type="button" value="Save"/> <input type="button" value="Cancel"/>			

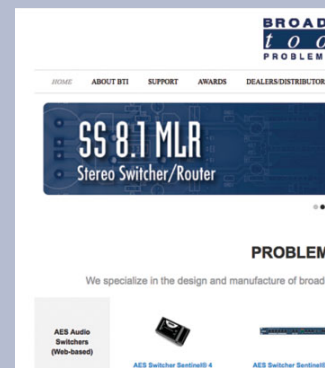
6. The default work mode is TCP Server, TCP Client, UDP Server and UDP Client are also available. To change the TCP port choose “Serial Port” from the side bar and change the “Local Port Number” setting:

Current Status	parameter	
Local IP Config	Baud Rate:	1200 bps(600~460.8K)
Serial Port	Data Size:	8 bit
Expand Function	Parity:	None
Misc Config	Stop Bits:	1 bit
Reboot	Local Port Number:	8001 (1~65535)
	Remote Port Number:	8234 (1~65535)
	Work Mode:	TCP Server
	Remote Server Addr:	192.168.0.201 [192.168.0.201]
	RESET:	<input type="checkbox"/>
	LINK:	<input checked="" type="checkbox"/>
	INDEX:	<input type="checkbox"/>
	Similar RFC2217:	<input checked="" type="checkbox"/>
	<input type="button" value="Save"/> <input type="button" value="Cancel"/>	

7. To save changes click “Save” then when prompted click "Restart Module” and “Ok” to reboot the web server module and allow the changes to take effect.

## WEBSITE:

Visit our web site for product updates and additional information.

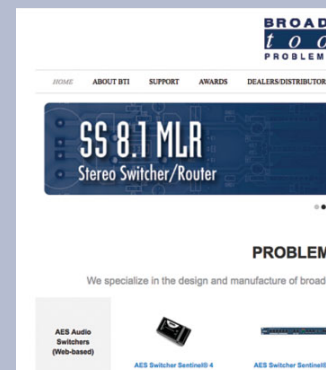


## Specifications

Station Inputs/Outputs:	Station In/Out: Balanced Analog Stereo RJ45 audio jacks. Any input level and impedance can be used. Output levels, impedance, distortion, noise, and balancing will match that of the selected input.
Station In/Out:	Balanced Analog Stereo RJ45 audio jacks. Any input level and impedance can be used. Output levels, impedance, distortion, noise, and balancing will match that of the selected input.
EAS Encoder Input:	Balanced mono input. -20dBv to +20dBu. Front panel adjustment.
Switching Method:	Passive. Sealed relays utilizing 2 x 2-form-C bifurcated-crossbar silver alloy with gold overlay contacts.
Logic:	Flash microprocessor with non-volatile memory.
Operation Control:	Front Panel: Recessed, defeatable momentary switches.
Remote:	Sustained, compatible with 5 volts CMOS/TTL logic, open collector or contact closures to ground.
Serial:	Multi-drop RS-232 1200 8,N,1, serial port (or optional TCP/UDP Ethernet port).
Status:	Front Panel: LED Indicators.
Remote:	Four SPST relays. 1-amp @ 30 VDC maximum.
Interfacing:	Station Audio I/O: Balanced RJ45 connectors. Normally closed pass-thru audio path.
Encoder Audio Input, and remote control:	Plug-in euroblock screw terminals. Mating connectors supplied.
Serial:	RJ-11 jack. Reversed RJ11 modular cable/female "S9" 9-pin D-Sub adapter supplied.
Power Supply:	Surge protected PS-1515/IEC universal switching +/-15VDC desktop power supply with locking connector and IEC AC inlet included. CE. (Includes domestic IEC AC power cord).
Operating Environment:	32°F/0°C-122°F/50°C; 0%-95% non-condensing relative humidity; 10,000ft/3048m.
Declaration of Conformity:	Email <a href="mailto:support@broadcasttools.com">support@broadcasttools.com</a> for more information.
Physical Dimensions:	5.66" x 7.125" x 1.58", aluminum extrusion chassis with (4) #6-32 screw thread mounting holes for optional RA-1 rack shelf.
Weight:	2.0 lb.
Shipping Weight:	3.0 lb.
Options:	RA-1 rack shelf, holds three units (1-RU), filler panel supplied.

### WEBSITE:

*Visit our web site for product updates and additional information.*



### SPECIFICATIONS

## LIMITED WARRANTY

The term “Buyer” as used in this document refers to and includes both (but only) (a) any person or entity who acquires such an item for the purpose of resale to others (i.e., a dealer or distributor of an item), and (b) the first person or entity who acquires such an item for such person’s or entity’s own use.

Broadcast Tools warrants to each Buyer of any item manufactured by Broadcast Tools that the item will be free from defects in materials and workmanship at the time it is shipped by Broadcast Tools if the item is properly installed, used and maintained.

## EXCLUSIVE REMEDIES

If Broadcast Tools is notified, in writing, of a failure of any item manufactured by Broadcast Tools to conform to the foregoing Limited Warranty within one (1) year following the date of the Buyer’s acquisition of the item, and if the item is returned to Broadcast Tools in accordance with Broadcast Tools’ instructions for confirmation by inspection of the defect (which at Broadcast Tools’ election may include, without limitation, a requirement that the Buyer first obtain a Return Authorization number from Broadcast Tools, that the Buyer furnish proof of purchase in the form of an invoice and/or receipt, and that the Buyer prepay all freight charges associated with any return of the item to Broadcast Tools using such freight service as Broadcast Tools reasonably may specify), Broadcast Tools will repair or replace the defective item, or will refund the purchase price paid by the Buyer for the item. Broadcast Tools shall have the exclusive right to choose between these alternative remedies.

## NO OTHER WARRANTIES OR REMEDIES

TO THE MAXIMUM EXTENT PERMITTED BY APPLICABLE LAW, BROADCAST TOOLS AND ITS SUPPLIERS DISCLAIM ALL OTHER WARRANTIES, EITHER EXPRESS OR IMPLIED, INCLUDING BUT NOT LIMITED TO IMPLIED WARRANTIES OF MERCHANTABILITY OR FITNESS FOR A PARTICULAR PURPOSE; AND THE FOREGOING ALTERNATIVE REMEDIES SHALL BE EXCLUSIVE OF ALL OTHER REMEDIES. THIS LIMITED WARRANTY GIVES YOU SPECIFIC LEGAL RIGHTS. YOU MAY HAVE OTHER RIGHTS, WHICH VARY FROM STATE/JURISDICTION TO STATE/JURISDICTION.

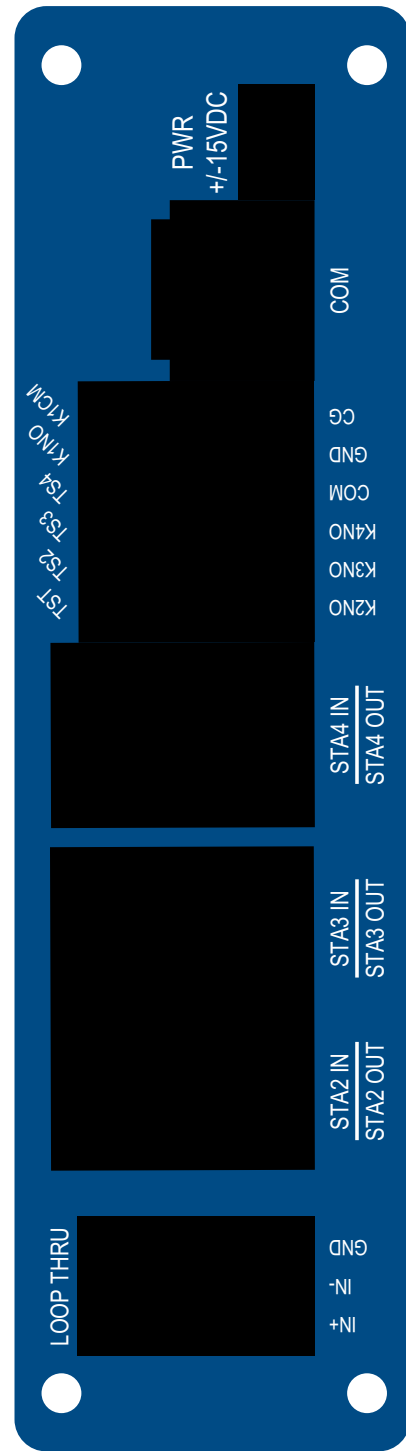
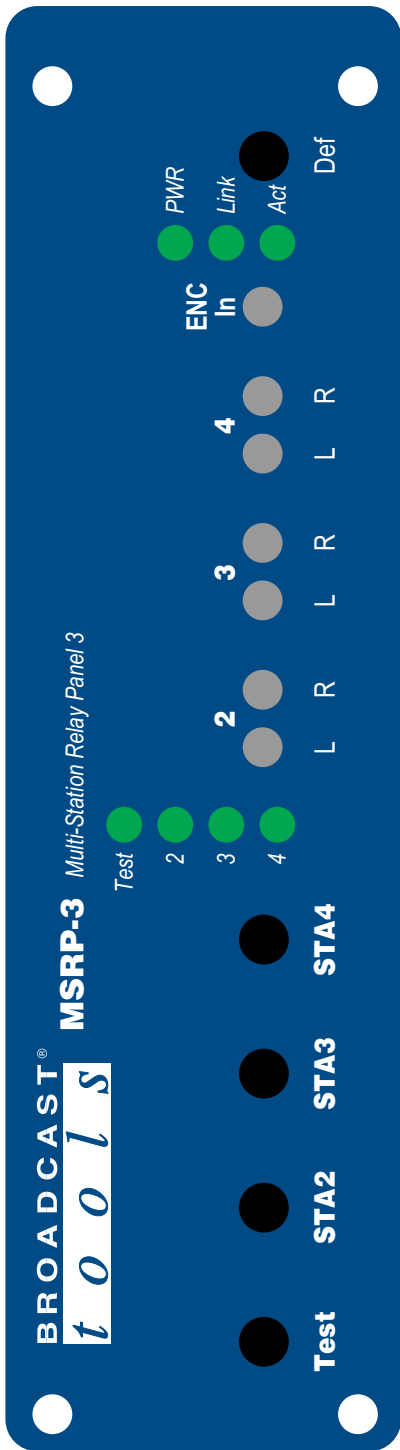
## NO LIABILITY FOR CONSEQUENTIAL DAMAGES

TO THE MAXIMUM EXTENT PERMITTED BY APPLICABLE LAW, NEITHER BROADCAST TOOLS NOR ANY OF ITS SUPPLIERS SHALL HAVE ANY LIABILITY FOR ANY SPECIAL, INCIDENTAL, INDIRECT, CONSEQUENTIAL OR PUNITIVE DAMAGES WHATSOEVER (INCLUDING, WITHOUT LIMITATION, ANY DAMAGES FOR LOST PROFITS, BUSINESS INTERRUPTION, LOSS OF DATA OR INFORMATION, COST OF CAPITAL, CLAIMS OF CUSTOMERS, OR ANY OTHER PECUNIARY LOSS) ARISING OUT OF THE USE OF OR THE INABILITY TO USE ANY ITEM SUPPLIED BY BROADCAST TOOLS, EVEN IF BROADCAST TOOLS HAS BEEN ADVISED OF THE POSSIBILITY OF SUCH DAMAGES HAVE ANY LIABILITY FOR ANY SPECIAL, INCIDENTAL, CONSEQUENTIAL, EXEMPLARY OR PUNITIVE DAMAGES. THIS LIMITATION OF LIABILITY APPLIES WHETHER A CLAIM IS ONE ALLEGING BREACH OF A CONTRACT OR WARRANTY, NEGLIGENCE OR OTHER TORT, FOR THE VIOLATION OF ANY STATUTORY DUTY, THE FAILURE OF ANY LIMITED OR EXCLUSIVE REMEDY TO ACHIEVE ITS ESSENTIAL PURPOSE, OR ANY OTHER CLAIM OF ANY NATURE. BECAUSE SOME STATES AND JURISDICTIONS DO NOT ALLOW THE EXCLUSION OR LIMITATION OF LIABILITY FOR INCIDENTAL OR CONSEQUENTIAL DAMAGES, THIS LIMITATION MAY NOT APPLY TO YOU.

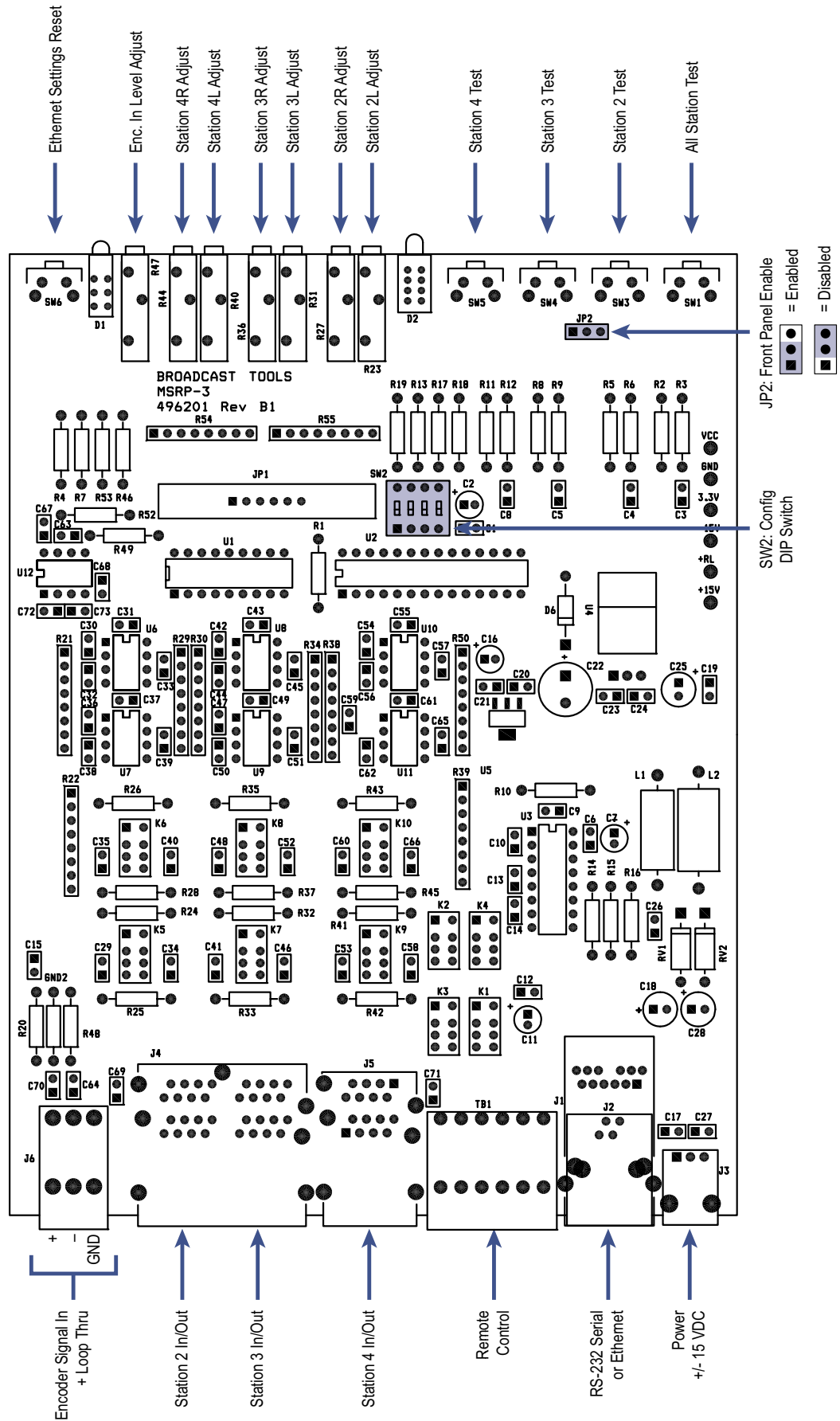
### **Broadcast Tools, Inc.**

131 State Street  
Sedro-Woolley, WA 98284 • USA

360.854.9559 **voice** • 866.783.1742 **fax**  
support@broadcasttools.com **e-mail**  
www.broadcasttools.com **website**



### Component Layout



131 State Street, Sedro-Woolley, WA 98284 • 360.854.9559 • Fax 866.783.1742

Visit us online at [www.broadcasttools.com](http://www.broadcasttools.com)

Copyright © 1989-2024 by Broadcast Tools, Inc. All Rights Reserved. Broadcast Tools is a Veteran Owned Business. Designed, Assembled and Supported in WA State, USA

Modified 05/15/24